



Description

SP0080SDT-3L TSS is a type of semiconductor component and specially provides dual line protection for RS485 application from damaging overvoltage transient events 6 kV / 3 kA @1.2 / 50 μ s - 8 / 20 μ s combination wave, 2 Ω .

This three pin modified DO214AB(SMC) solution provides a small footprint, lower component count and excellent clamping performance than traditional GDT and TVS combination solution.

Pinout and Schematic Symbol

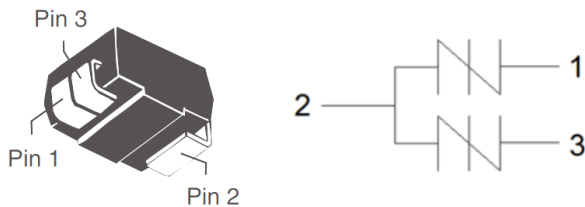

Features

- Lower capacitance
- Low profile package
- Low on-state voltage
- Excellent capability of absorbing transient surge
- Quick response to surge voltage (ns Level)
- Eliminates overvoltage caused by fast rising transients
- Moisture sensitivity level: Level 1
- Non degenerative
- Flammability Rating: UL 94 V-0
- Halogen free and RoHS compliant

Order Information

Type	Package	Marking Code	Delivery Form	Delivery Quantity
SP0080SDT-3L	SMC-3L	P08T	13" T&R	3000 PCS

Limiting Values

(T_A = 25 °C, unless otherwise specified)

Symbol	Parameter	Conditions	Min	Max	Unit
I _{PP}	Repetitive peak pulse current	8 / 20 μ s ¹	3000	3450	A
T _J	Operating Temperature Range	-	-40	150	°C
T _{stg}	Storage Temperature Range	-	-55	150	°C

¹ Surge test in compliance with IEC61000-4-5, peak open circuit voltage waveform 1.2 / 50 μ s, peak short circuit current waveform 8 / 20 μ s@ 2 Ω combination wave.

Package Dimensions

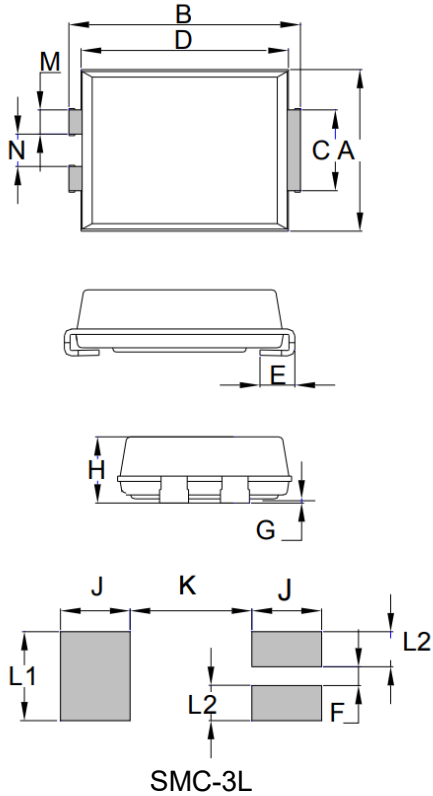

Symbol	Millimeters		Inches	
	Min.	Max.	Min.	Max.
A	5.75	6.25	0.226	0.246
B	7.70	8.20	0.303	0.323
C	2.75	3.25	0.108	0.128
D	6.90	7.40	0.272	0.291
E	0.95	1.52	0.037	0.060
G	-	0.30	-	0.012
H	2.15	2.62	0.085	0.103
M	0.70	1.10	0.028	0.043
N	1.00	1.40	0.039	0.055
L2	1.30	-	0.051	-
F	0.70	-	0.028	-
J	2.40	-	0.094	-
K	-	4.20	-	0.165
L1	3.30	-	0.130	-

Part Numbering System

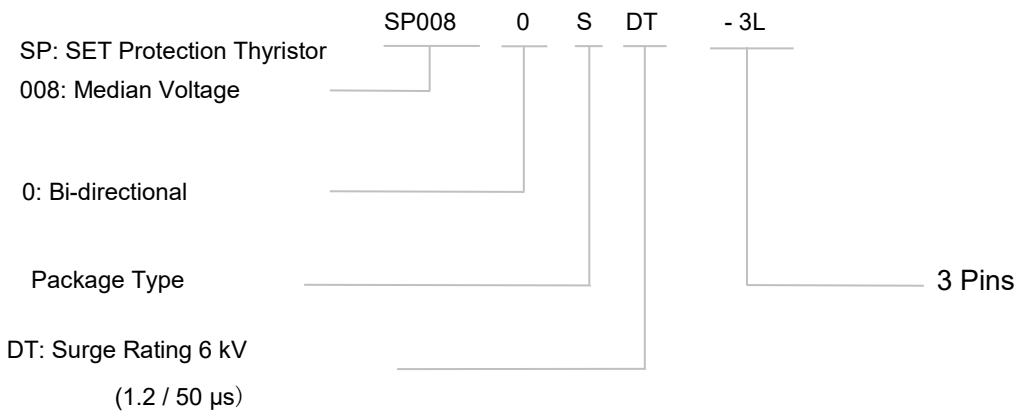

Marking

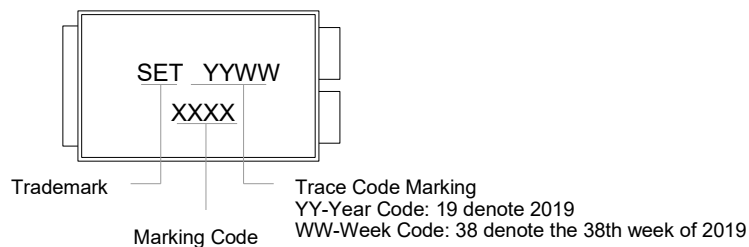

Electrical Characteristics

(T_A = 25 °C, unless otherwise specified)

Part Number	T _A	I _{DRM} @V _{DRM}		V _S ¹ @I _S		V _T @I _T		I _H	Capacitance ²	
		μA	V	V	mA	V	A	mA	pF	
		max	Pin 1,3-2	Pin 1,3-2	-	max	-	min	min	max
SP0080SDT-3L	25 °C	5	6	15	800	4	2.2	50	400	700
	125 °C	20	6	15	800	4	2.2	35	400	700

¹ V_S is measured at 100 kV / s.

² Off-state capacitance is measured in V_{DC}=2 V, V_{RMS}=1 V, f=1 MHz.

Symbol	Parameter
V _{DRM}	Peak off-state voltage
I _{DRM}	Off-state current
V _S	Switching voltage
I _S	Switching current
V _T	On-state voltage
I _T	On-state current
I _H	Holding current
C _O	Off-state capacitance

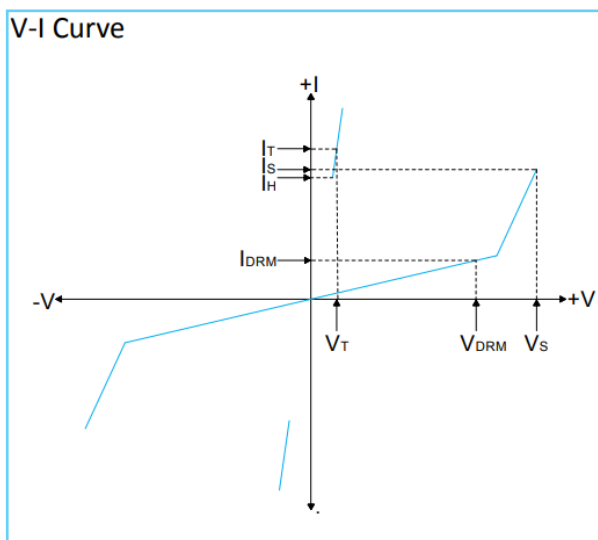

Performance Curve for Reference

($T_A=25\text{ }^\circ\text{C}$ unless otherwise noted)

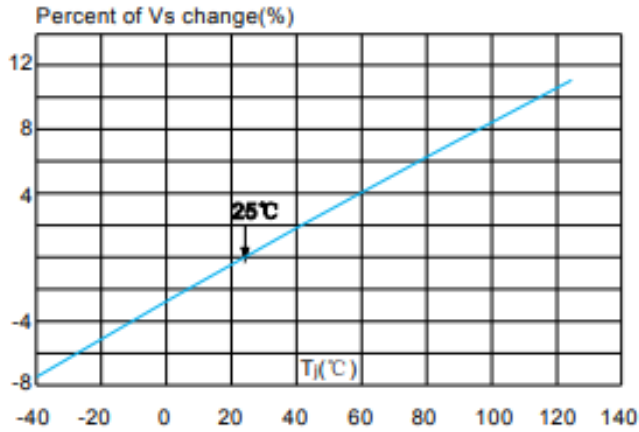

FIGURE 1

Normalized VS. Change VS. Junction Temperature

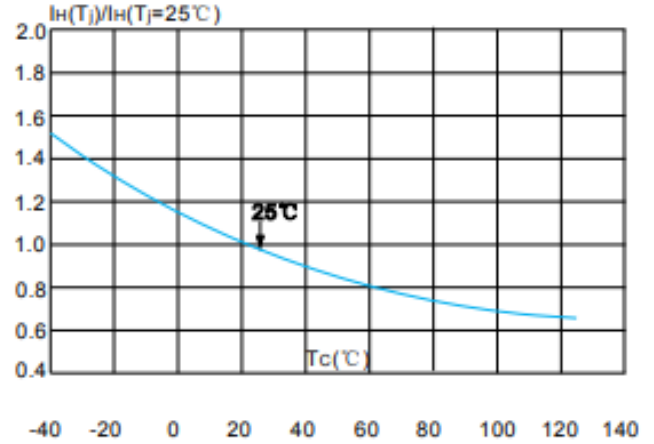

FIGURE 2

Normalized DC Holding Current VS. Case Temperature

Environmental Specifications

High Temp. Storage	JESD22-A103
HTRB	JESD22-A108
MSL	JESDEC-J-STD-020, Level 1
Temperature Cycling	JESD22-A104
H3TRB	JESD22-A101
RSH	JESD22-A111

Physical Specifications

Weight	0.007 ounce, 0.21 grams
Case	JESD22DO214AB. Molded plastic body over glass passivated junction
Polarity	Color band denotes positive end (cathode) except Bidirectional
Terminal	Matte Tin-plated leads, Solderability per JESD22-B102

Soldering Parameters

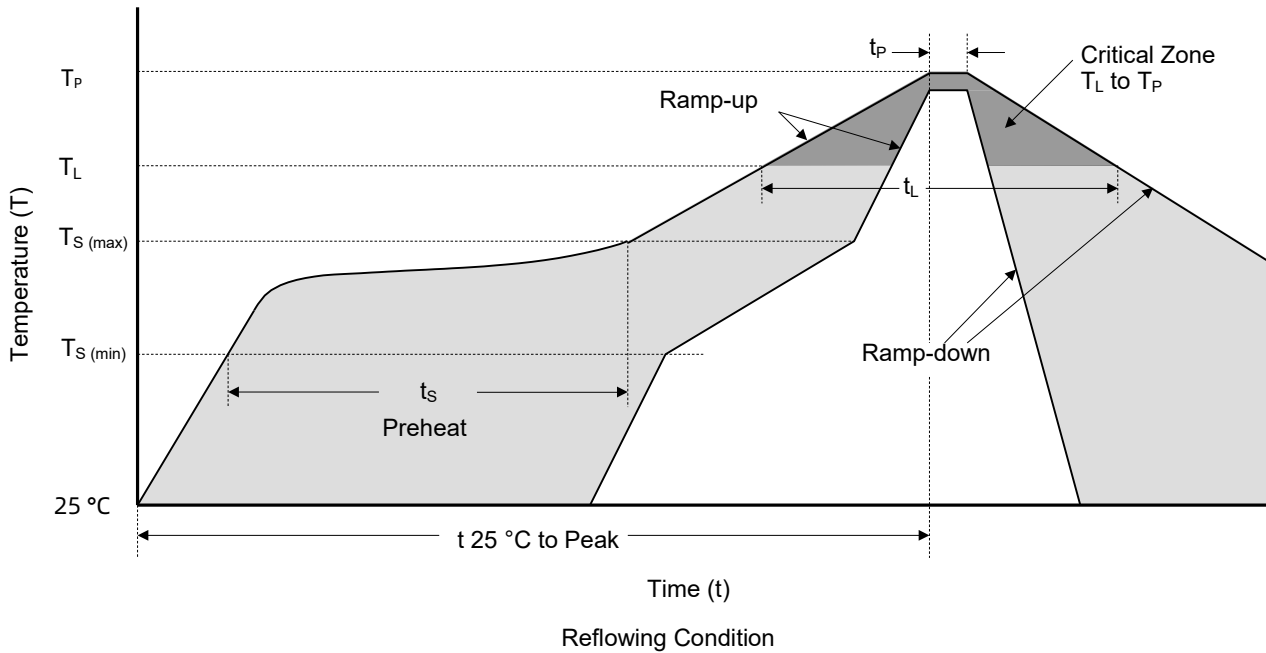

Reflow Soldering Parameters		Lead-Free Assembly
Pre-heat	Temperature Min ($T_{S (min)}$)	150 °C
	Temperature Max ($T_{S (max)}$)	200 °C
	Time (min to max) (t_s)	60 ~ 120 seconds
Average Ramp Up Rate (Liquidus Temp (T_L) to Peak Temp (T_P))		3 °C / second max.
$T_S (max)$ to T_L -Ramp-up Rate		3 °C / second max.
Reflow	Temperature (T_L)	217 °C
	Time (t_L)	60 ~ 150 seconds
Peak Temperature (T_P)		260 ^{+0/-5} °C
Time of within 5 °C of Actual Peak Temperature (t_p)		30 seconds
Ramp-down Rate		6 °C / second max.
Time From 25 °C to Peak Temperature		8 Minutes max.
Do Not Exceed		260 °C

Packaging Information

Tape	Symbol	Dimension (mm)
	W	16.00 + 0.3 / -0.1
	P ₀	4.00 ± 0.10
	P ₁	8.00 ± 0.10
	P ₂	2.00 ± 0.10
	D ₀	1.55 ± 0.05
	D ₁	1.55 ± 0.05
	E	1.75 ± 0.10
	F	7.50 ± 0.10
	A ₀	6.15 ± 0.10
	B ₀	8.30 ± 0.10
	K ₀	2.48 ± 0.10
	T	0.30 ± 0.05

Reel Size	13" Reel	
	A	330 mm
	C	13.2 mm
	W ₁	12.5 mm

Part Number	Package	QTY (Reel)	Packaging Option	Packaging Specification
SP0080SDT-3L	SMC-3L	3000 PCS	Tape & Reel – 12mm tape/13" reel	EIA STD RS-481



ATTENTION

Usage

1. TSS must be operated in the specified ambient temp..
2. Do not clean the TSS with strong polar solvent such as ketone, esters, benzene and halogenated hydrocarbon, to avoid damaging the encapsulating layer.
3. Please do not apply severe vibration, shock or pressure to TSS, to avoid element cracking.

Replacement

1. If TSS is visually damaged, please replace it.
2. TSS is a non-repairable product. For safety sake, please use equivalent TSS for replacement.

Storage

1. Storage Temp. Range: (-55 to 150) °C.
2. Do not store the TSS at the high temp., high humidity or corrosive gas environment, to avoid influencing the solder- ability of the lead wires. The product shall be used up within 1 year after receiving the goods.

Environmental Conditions

1. TSS should not be exposed to the open air, nor direct sunshine.
2. TSS should avoid rain, water vapor or other condition of high temp. and high humidity.
3. TSS should avoid sand dust, salt mist, or other harmful gases.

Max. Typical Capacitance of TSS

The typical capacitance of TSS is listed in the specifications. Designers may refer to it when designing TSS in High frequency circuit.

Installation Mechanical Stress

1. Do not knock TSS when installing, to avoid mechanical damage.
2. Please do not apply severe vibration, shock or pressure to TSS, to avoid surface resin or element cracking.

Thyristor Surge Suppressors (Surface Mount) Feature Overview

Package Type	Series								
	SP0080TALC	SP0080TBLC	SPxxxxSA	SPxxxxSB	SPxxxxSC	SPxxxxSD	SPxxxxSDT	SP0080SDT-3L	SIP5024G
DO-214AA									
DO-214AB									
DO-214AC									
SOD-23-6									
Product Outline (mm)									
Surge Rating	A (2 kV @ 10/700 μs)	B (4 kV @ 10/700 μs)	B (4 kV @ 10/700 μs)	B (4 kV @ 10/700 μs)	C (6 kV @ 10/700 μs)	D (8 kV @ 10/700 μs)	DT (6 kV@ 1.2/50 μs)	DT (6 kV@ 1.2/50 μs)	NA
V _{DRM} (V) Peak off-state voltage	6	6	58 ~ 340	6 ~ 400	6 ~ 440	6 ~ 400	6, 15, 400	6	24
I _{PP} (A) (8/20 μs) Repetitive peak pulse current	90	250	250	250	400	700	3000	3000	35
C _J (pF) capacitance	10	30	20 ~ 35	25 ~ 50	35 ~ 60	40 ~ 150	500, 250, 170	700	11
Operating Temperature (°C)	-55 to +150								